

Схема сборки фонтана артикул 851

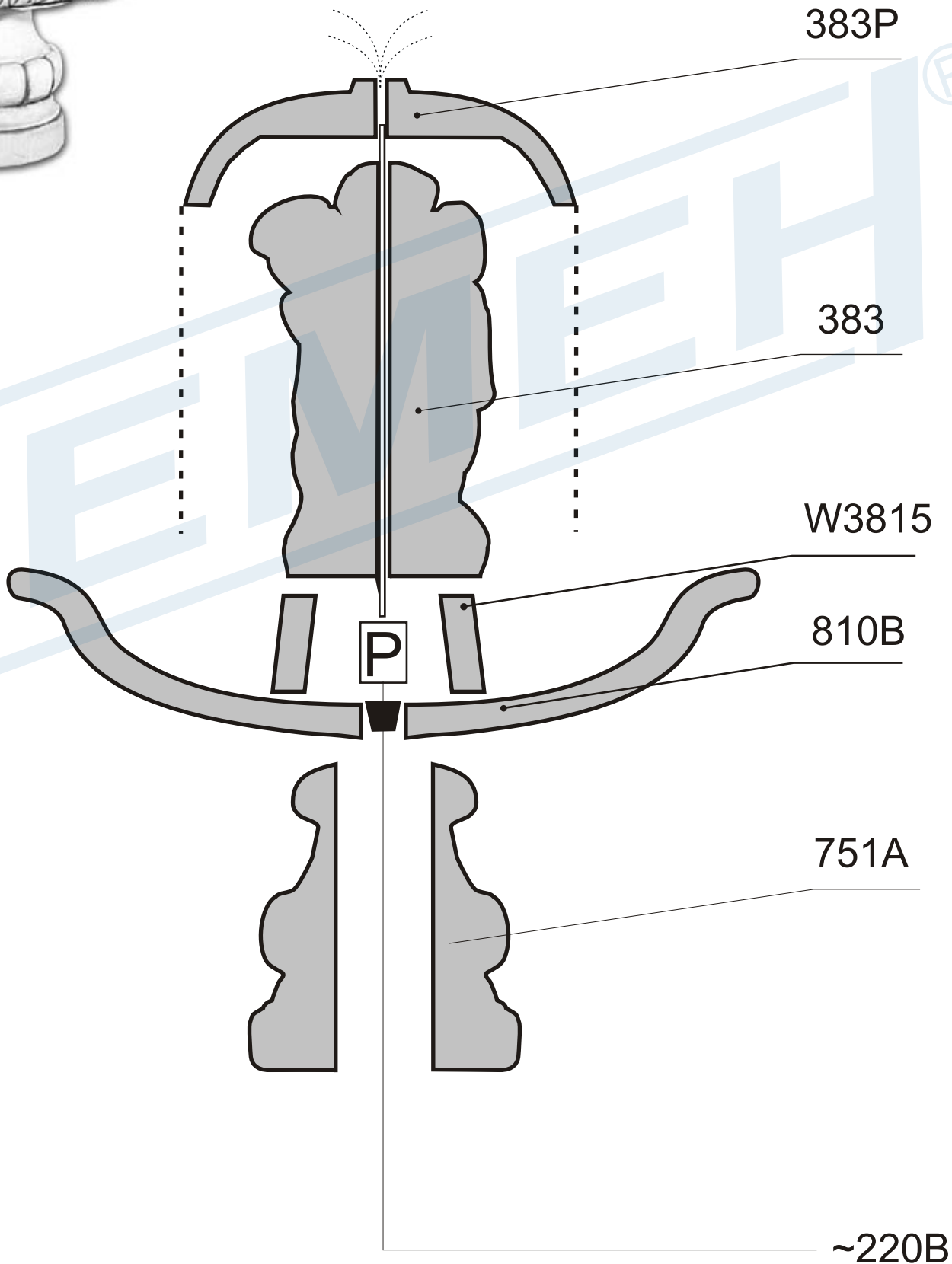

383P

383

W3815

810B

751A

~220B